

INTEG **M** HYBRID INVERTER

Solinteg MHT-25~50K
Hybrid Inverter









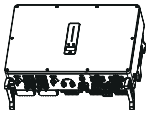
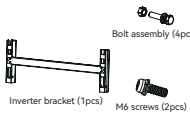
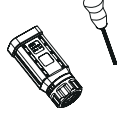

Quick Installation Guide

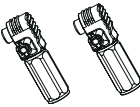
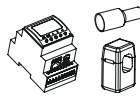
ENGLISH VERSION

1 Installation

A Check Packing List

 Inverter 1pcs	 Inverter bracket (1pcs) M6 screws (2pcs)	 AC connector set (3 pcs)	 PV terminal MHT-25-50K 8 pairs / MHT-40-50K-P 6 pairs
 Battery terminal (1 pairs)	 Meter with 3 CTs 1pcs	 COM2 connector set (1pcs)	 COM3 connector set (1pcs)
 Monitoring device 1pcs	 10m meter communication cable 1pcs 3m battery communication cable 1pcs	 PE terminal 1pcs	 User Manual User guide

B Installation Location

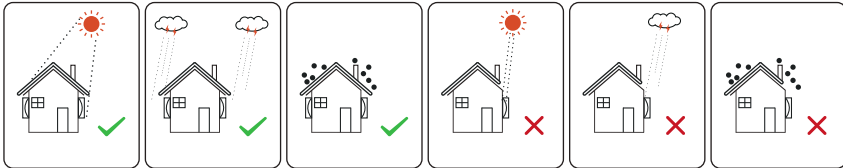

C Installation Space

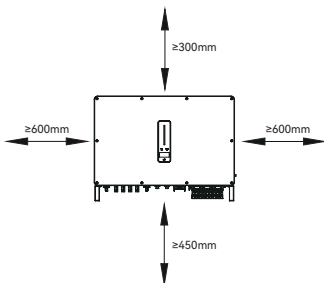

D Installation Angle

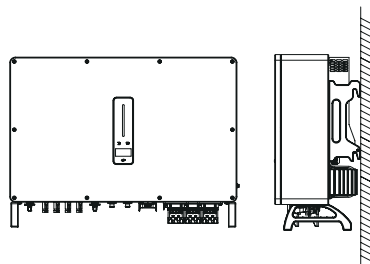

E Mark the Position and Drill Holes

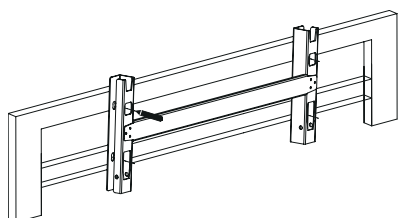

F Fix Wall Bracket

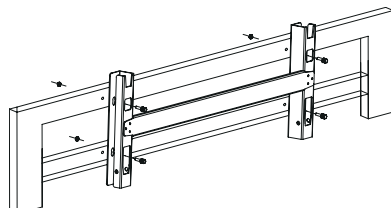

G Mounting Inverter

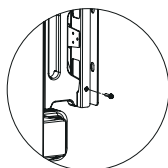
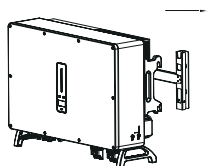

H Grounding Terminal Connection

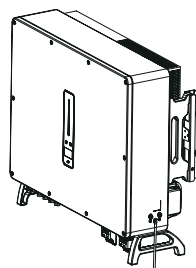

2 Electrical Connection

A Cable Requirements

Cable types	Cable requirements	
	Outside diameter	Conductor core section
AC cable	20.0-30.0 mm	10.0-25.0mm ² (Flexible cable)
		10.0-35.0mm ² (Hard cable)
PV cable	5.9-8.8 mm	4.0 mm ²
Battery power cable	9.8±0.2 mm	25.0 mm ²

Please use the cable specified in the above table. If the conductor core of the cable is too small, which may cause poor contact between the terminal and cable.

B Electrical Wiring Diagram

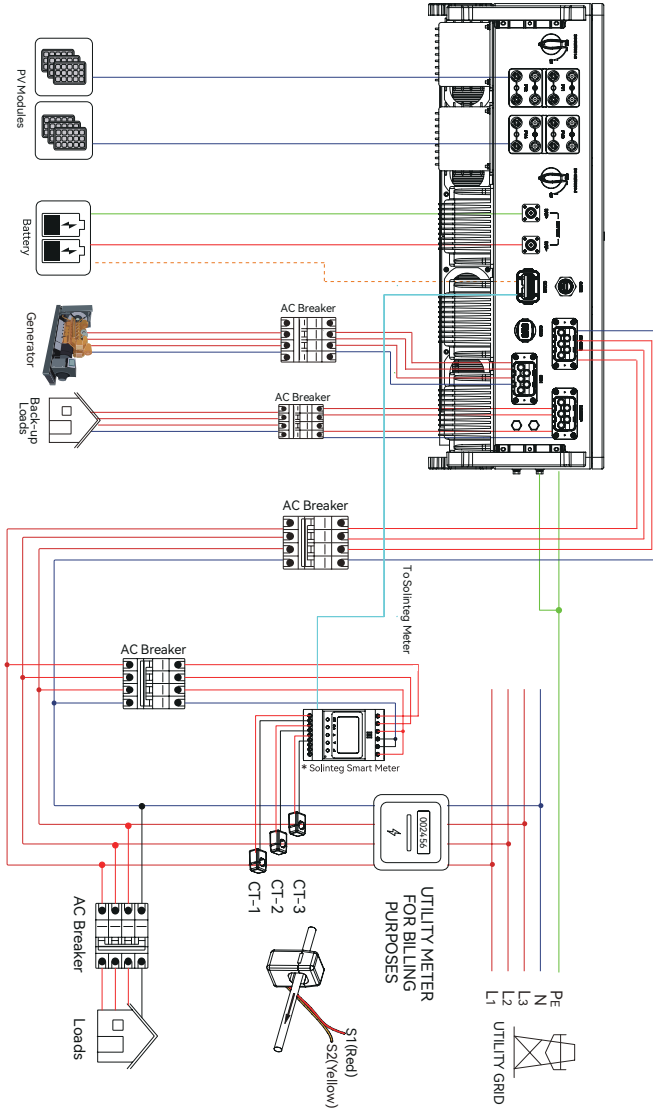

*Solinteg Smart Meter consists of ACR10R and RMM. Define the cable connections for the meter based on the actual meter model and refer to Meter Terminals Definition. This cable diagram is for reference only.

C AC Connection

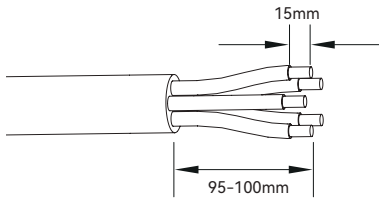

①

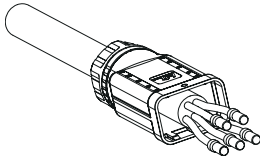

②

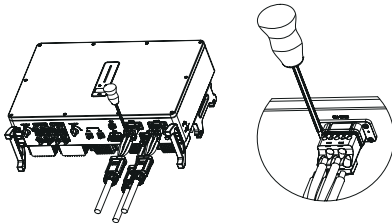

③

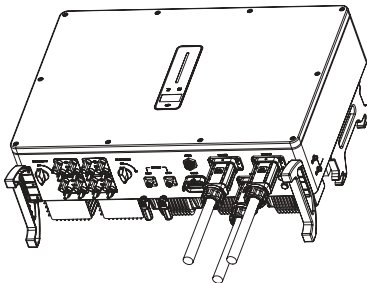

④

D Monitoring Device Installation

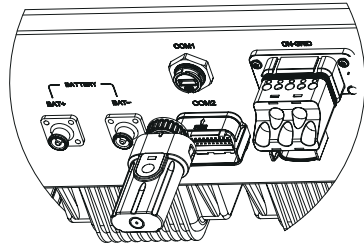

E Meter and CT Connection

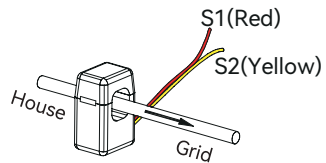
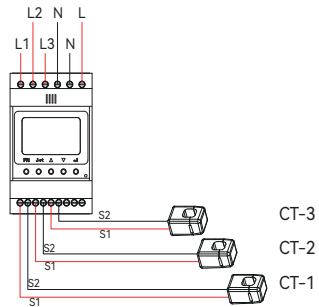
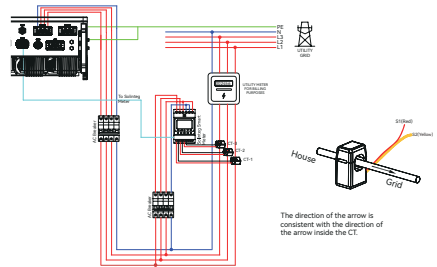

Meter Terminals Definition

No.	Definition		Function
	ACR10R	RMM	
1		L1	L1/L2/L3/N connect to grid to detect power grid voltage
2		L2	
3		L3	
4		N	
5		L1-S1	To detect the CT current and direction
6		L1-S2	
7		L2-S1	
8		L2-S2	
9		L3-S1	
10		L3-S2	
11	/	PE	Ground connection
12	L	/	Power supplied from grid
13	N	/	
RS485	/	Reserve	Communicate with hybrid inverter
	RS485	RS485-2	
ANT	/	Reserve	
LAN	/	Reserve	
Type-C	/	Type-C	Specified Debug Interface. Do not use it by non-professionals

F Communication Connection

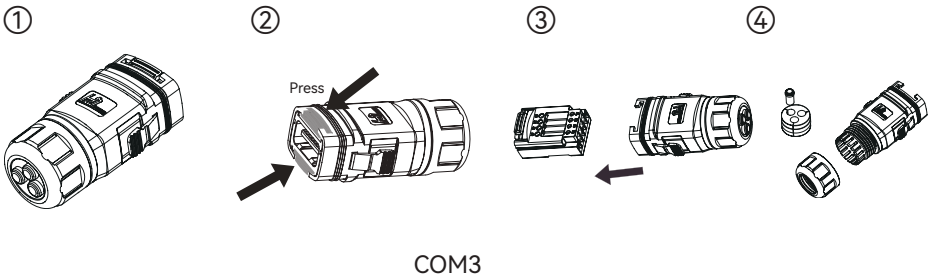
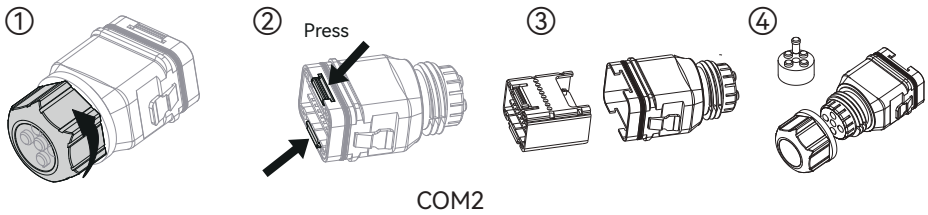

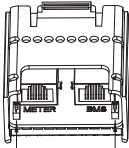

Terminating resistor for CAN(Parallel)
Terminating resistor for RS485(EMV)

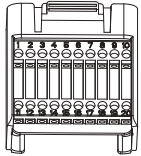

COM2

Pin	Definition	Function
METER (RJ45-1)	RS 485	Communicate with Meter
BMS (RJ45-1)	CAN	Communicate with BMS
1	COM	DO-1 (Multifunction Relay)
2	NO (Normally Open)	
3-4	/	Reserved
5	DRM4/8	DRED For Australia and New Zealand
6	DRM3/7	
7	DRM2/6	
8	DRM1/5	
15	COM D/0	Reserved
16	REF D/0	
9-10	/	Fast stop
11	Fast stop +	
12	Fast stop -	EMS
13	485 B1	
14	485 A1	
17	CANL_P	CAN for parallel connection of inverters
18	CANH_P	
19-20	/	Reserved



COM3

Pin	Definition	Function
1-6	/	Reserved
7	COM	DO-2 (Multifunction Relay)
8	NO	
9-10	/	Reserved
11	COM	DO-3 (Multifunction Relay)
12	NC	
13-16	/	Reserved
17	4-20mA_OUT	4-20mA analog output
18	GND	
19	GND	0-10V analog output
20	0-10V_OUT	

Connect the Meter and BMS Communication Cables

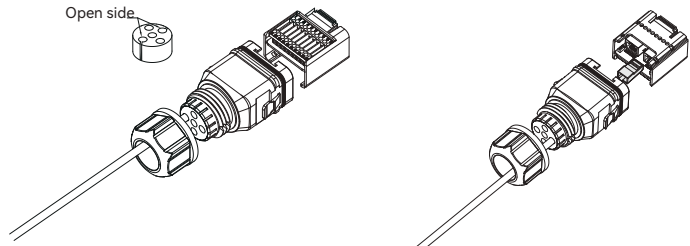

COM2

Connect Other Cables

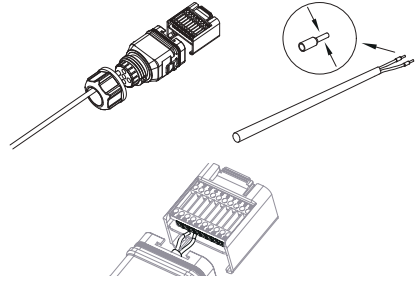
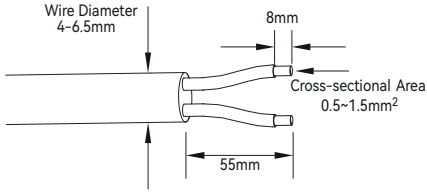

COM2

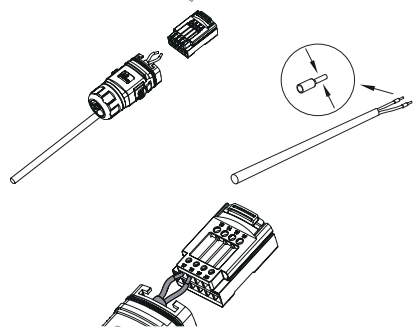
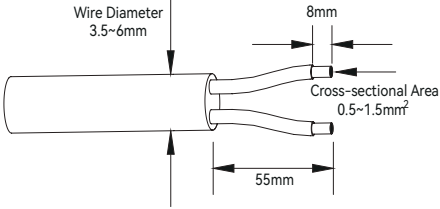

COM3

Installing the COM Connector

①

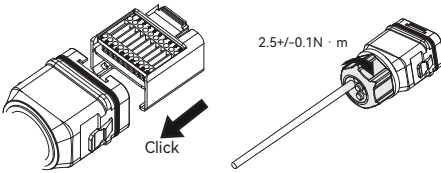

COM2

②

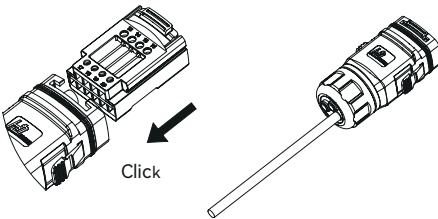

COM3

③

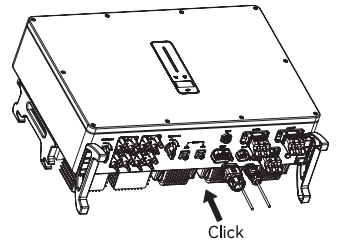

G PV String Connection

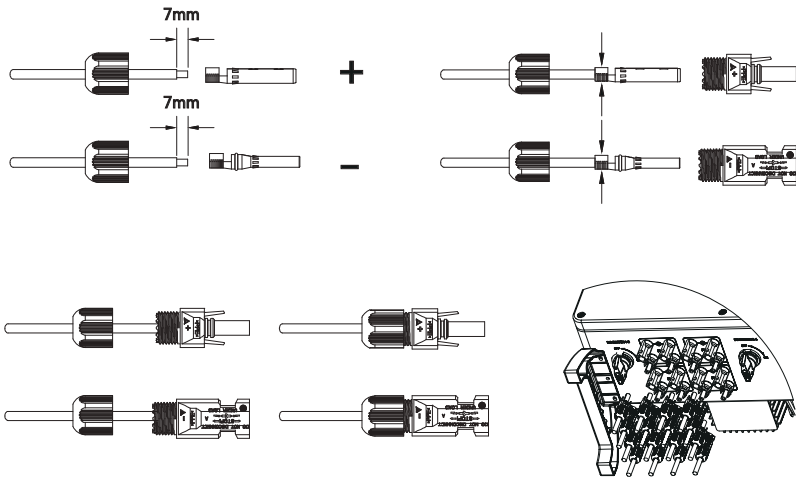

PV Max. Input voltage is 850V , otherwise inverter will be waiting.

H Power Cable of the Battery Connection

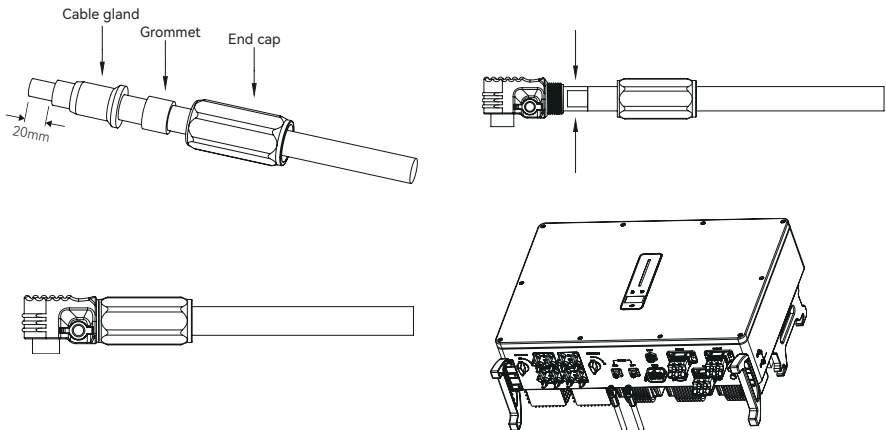

I N T E G R A T E S O L A R I N T E L L I G E N T



www.solinteg.com

M11-00012-01